



RANEBROOK
windows



Technical Drawing

Spiral Sash Window

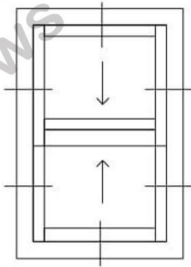
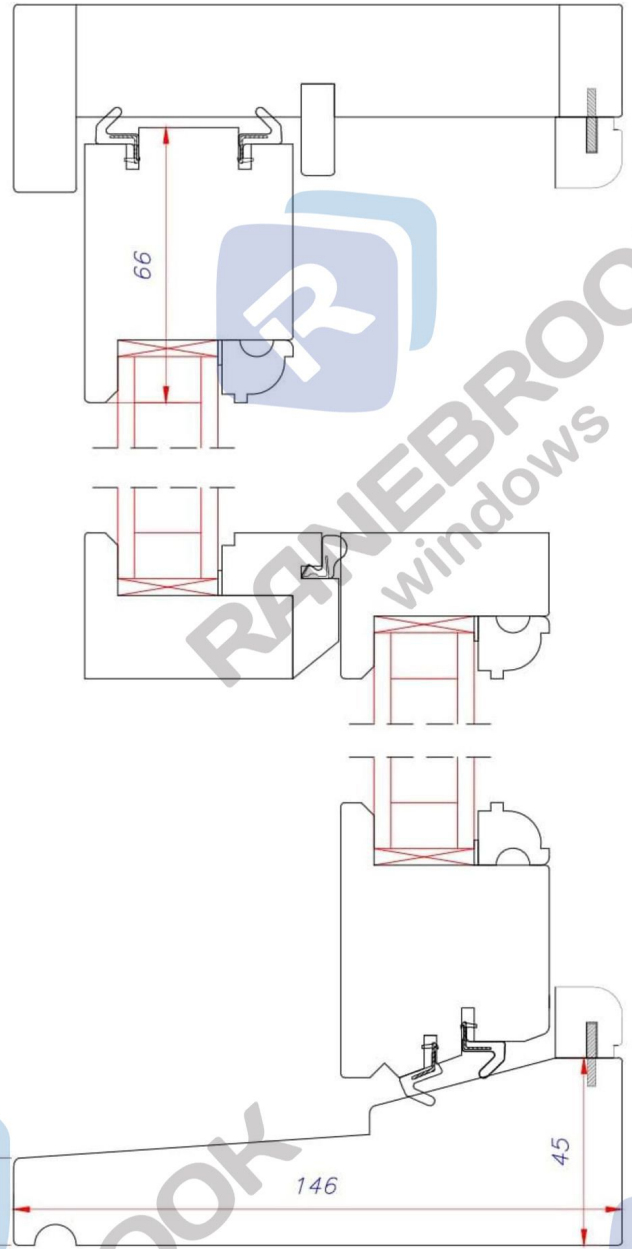
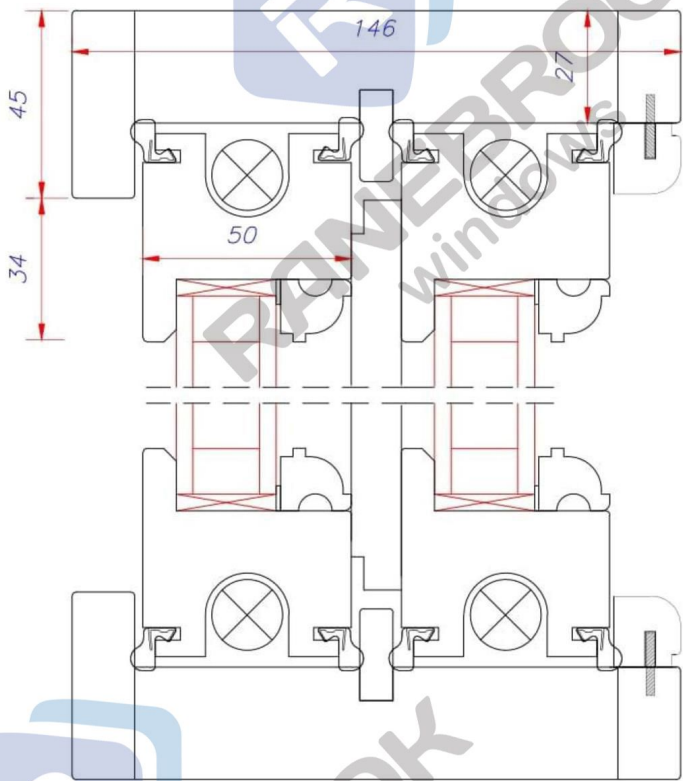

TITLE:
SASH BALANCE 50/45
WITH OGEE BEADINGS AND STAFF BEAD MODEL3



Scale: DO NOT SCALE PRINT

e: info@ranebrook.co.uk

83 High Street
 Chesham
 Buckinghamshire
 HP5 1DE

NOTES:

t/f: 01322 332237

Unless otherwise specified,
 dimensions are in millimetres.
 Unmarked tolerances: 0.=±0.5
 0.0=±0.25 0.00=±0.1

DRAWING NO:	REVISION
ENQUIRY NO: N/A	
DRAWING BY: CHECKED	DATE

web: www.ranebrook.co.uk

This drawing is the property of RANEBROOK WINDOWS LTD and must not be copied in whole or in part without written permission. No manufacturing rights are held by any party without the prior consent of RANEBROOK WINDOWS LTD. Possession of any drawings does not constitute an order to manufacture.

IF IN DOUBT, ASK

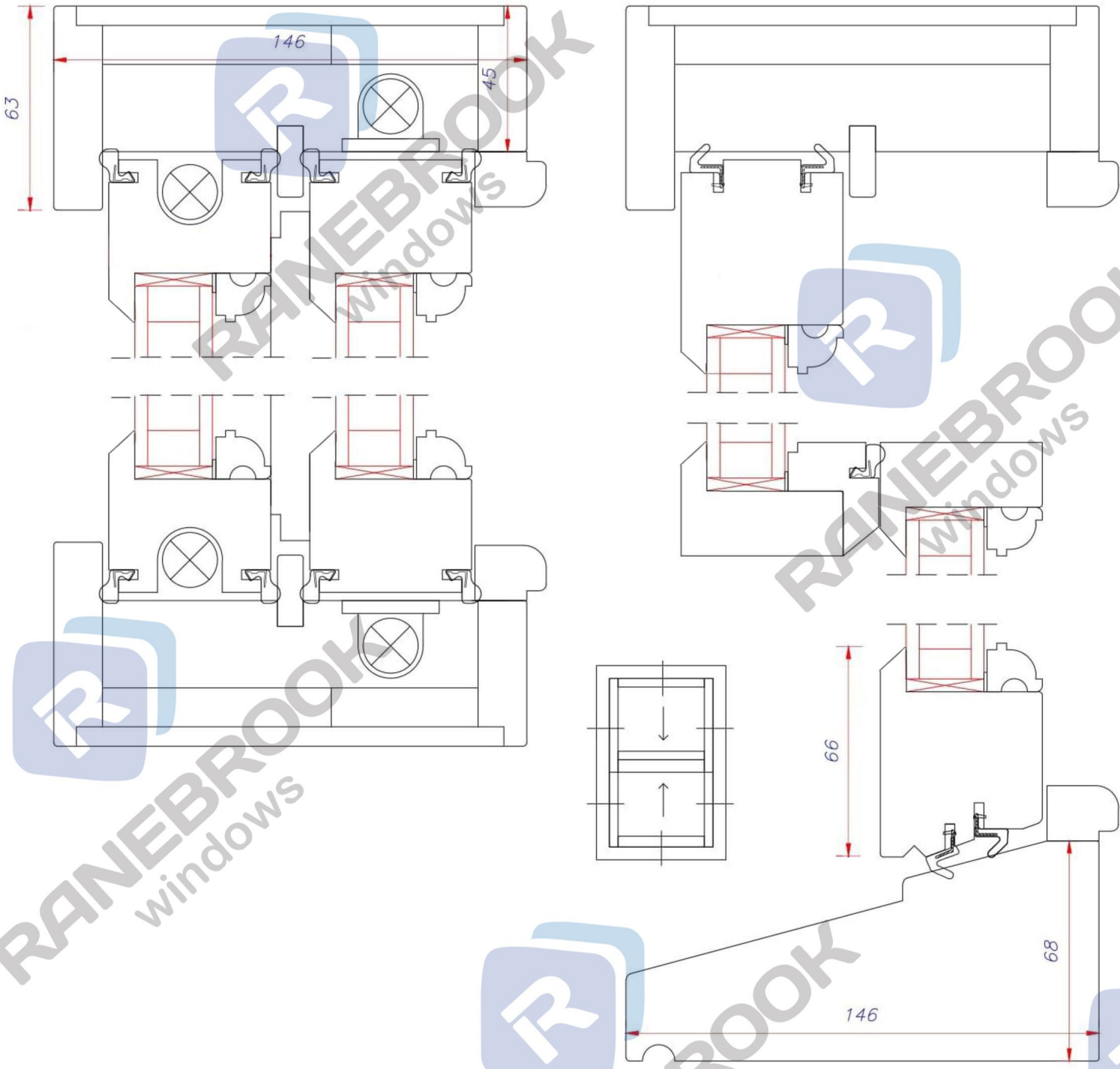

TITLE:
SS HIDDEN BALANCE BM 146 SW50



Scale: DO NOT SCALE PRINT

NOTES:
 Unless otherwise specified, dimensions are in millimetres.
 Unmarked tolerances: 0.=±0.5
 0.0=±0.25 0.00=±0.1

DRAWING NO:		REVISION	
ENQUIRY NO:	N/A		
DRAWING BY	CHECKED	DATE	

e: info@ranebrook.co.uk
 t/f: 01322 332237
 web: www.ranebrook.co.uk

83 High Street
 Chesham
 Buckinghamshire
 HP5 1DE

This drawing is the property of RANE BROOK WINDOWS LTD and must not be copied in whole or in part without written permission. No manufacturing rights are held by any party without the prior consent of RANE BROOK WINDOWS LTD.
 Possession of any drawings does not constitute an order to manufacture.

IF IN DOUBT, ASK

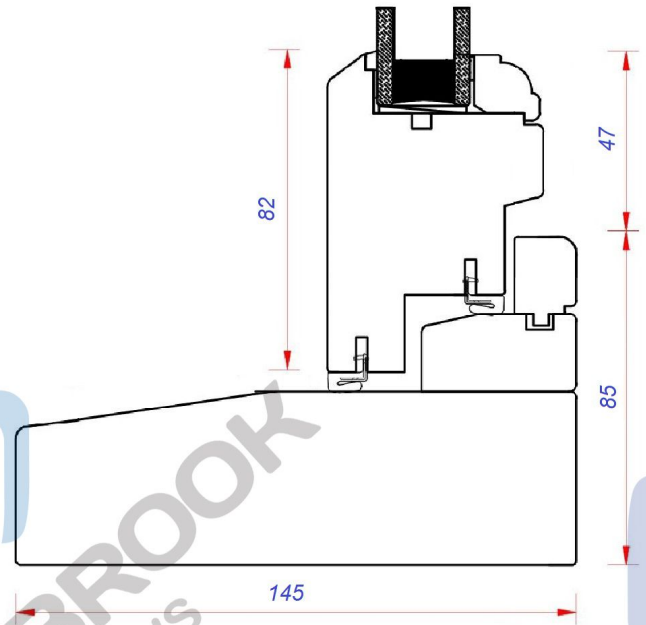
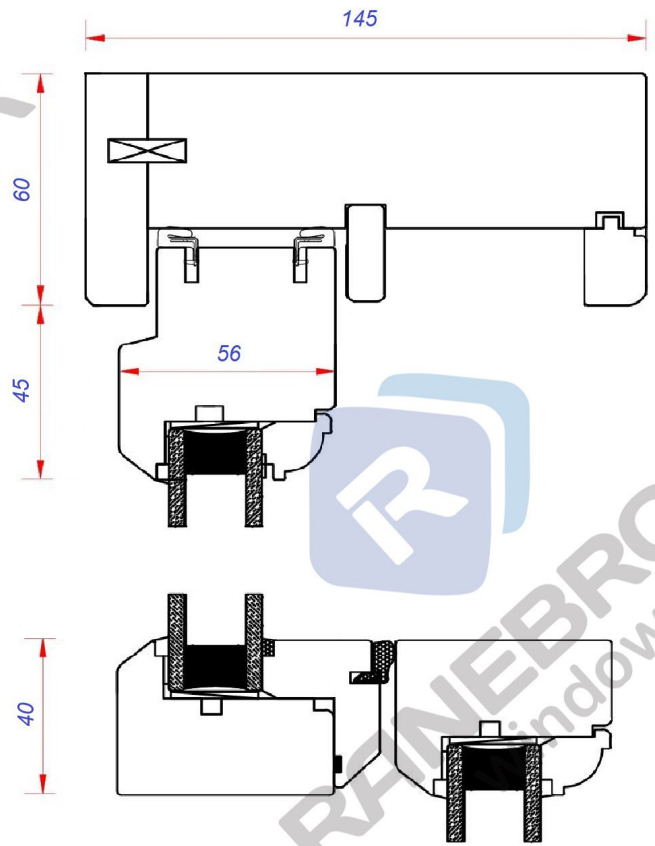
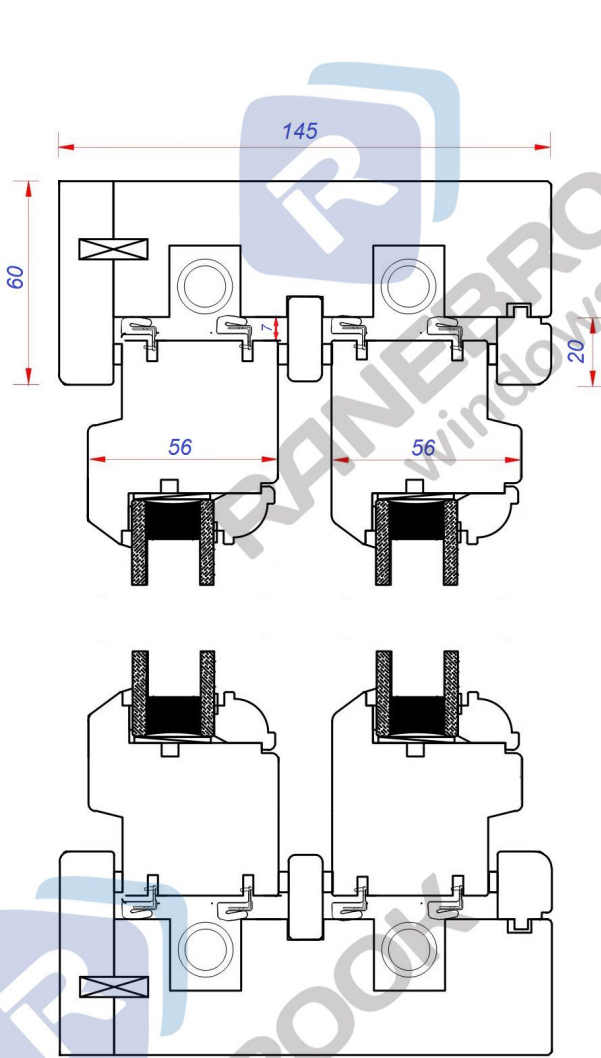

TITLE:

SASH BALANCE 145 SW56



Scale: DO NOT SCALE PRINT

e: info@ranebrook.co.uk

83 High Street
Chesham
Buckinghamshire
HP5 1DE

NOTES:

Unless otherwise specified, dimensions are in millimetres.
Unmarked tolerances: 0.=±0.5
0.0=±0.25 0.00=±0.1

DRAWING NO:

REVISION

t/f: 01322 332237

ENQUIRY NO:

N/A

web: www.ranebrook.co.uk

DRAWING BY

CHECKED

DATE

This drawing is the property of RANE BROOK WINDOWS LTD and must not be copied in whole or in part without written permission. No manufacturing rights are held by any party without the prior consent of RANE BROOK WINDOWS LTD.
Possession of any drawings does not constitute an order to manufacture.

IF IN DOUBT, ASK

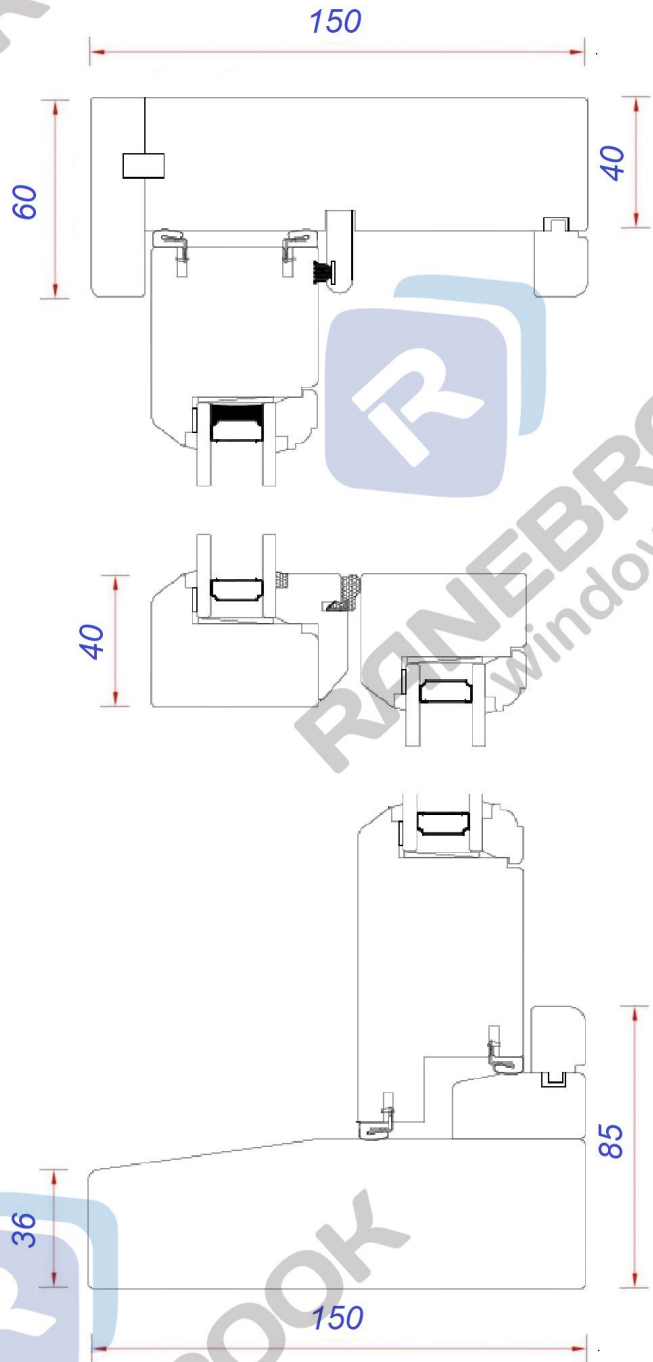
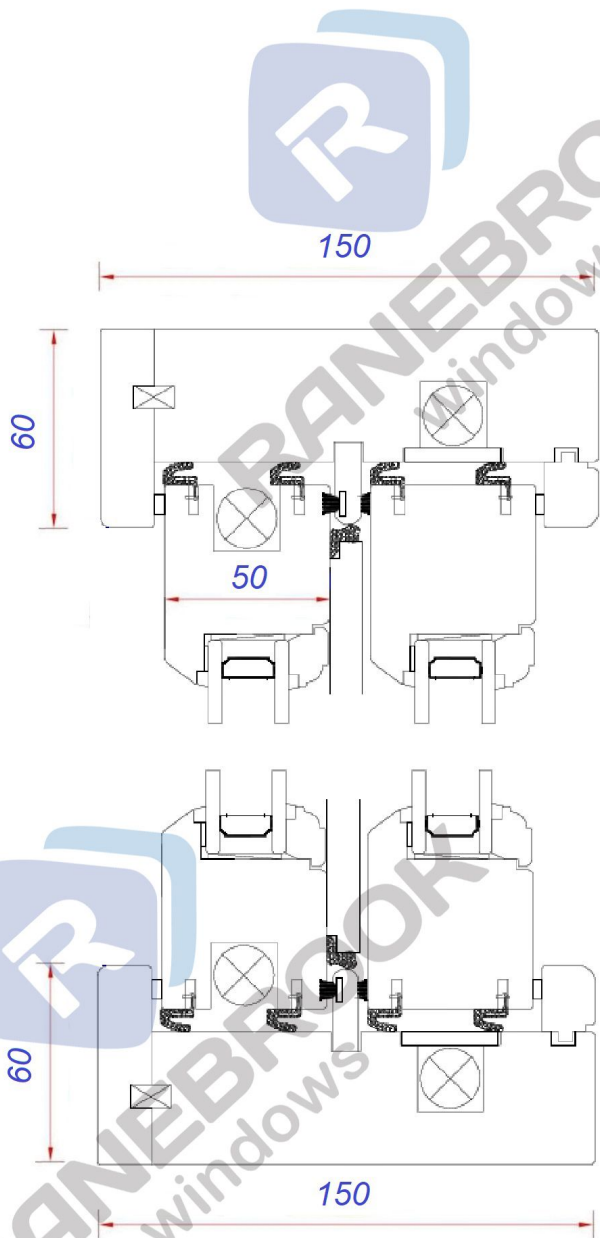

TITLE:

SS HIDDEN BALANCE 150 SW50



RANEBROOK
windows

Scale: DO NOT SCALE PRINT

e: info@ranebrook.co.uk

83 High Street
Chesham
Buckinghamshire
HP5 1DE

NOTES:

Unless otherwise specified, dimensions are in millimetres.
Unmarked tolerances: 0.=±0.5
0.0=±0.25 0.00=±0.1

DRAWING NO:	ENQUIRY NO:	DRAWING BY	CHECKED	REVISION	DATE
	N/A				

t/f: 01322 332237

web: www.ranebrook.co.uk

This drawing is the property of RANEBROOK WINDOWS LTD and must not be copied in whole or in part without written permission. No manufacturing rights are held by any party without the prior consent of RANEBROOK WINDOWS LTD.
Possession of any drawings does not constitute an order to manufacture.

IF IN DOUBT, ASK